

Proficient ways of paper machine design concepts *(Fluting/Linerboard machines)*

K.G. Rajan – Alsip Minimill, USA

S. Thayumanaswamy and K. Dhamodharan

Minimill Technologies Services International Pvt. Ltd, India

Author



K.G. Rajan,
President – Alsip Minimill, USA

K.G. Rajan,

B.Tech - Chemical Engineering IIT – Madras

MS - Paper Science Engineering SUNY-ESF Syracuse, NY

MBA University of Toronto

President – Alsip Minimill, a fine paper mill that was converted to containerboard mill. Former President - Minimill Technologies (MMT), USA and Vice President – Solvay Paper & Boards, Syracuse, NY.

Rajan was involved in the Design, Construction, Start-up & Operation of four best containerboard mills in USA (Three Solvay Paper & Boards, Syracuse, NY and Greenpac, Niagara Falls, NY).

He also led in the conversion of both SP Fiber Technologies, a newsprint mill and Alsip Minimill, a fine paper mill, to containerboard mills.

Rajan gained his mill operation experience from Seshasayee Paper & Boards India, Sonoco, Paperboard Industries, Solvay Paperboard and Alsip Minimill; and his engineering experiences were honed by his stints at Chas T Main, Stone & Webster Engineering and Minimill Technologies, USA (MMT).

Introduction

The article will discuss in detail on “**Proficient ways of Paper Machine design concepts and conversion of LWC or Writing & Printing PM/c to Fluting or Linerboard machines**”.

It consists of technology highlights such as:

- Compact Layout Design
- Efficient selection and upgradation of PM modules
- Potential Energy from outbound effluent & PM condensate
- Conservation of fresh water.
- Fully Automated OCC Feed System.

Aspects to be considered while designing:

- Basic design and dimensioning are based on low energy consumption.
- Reduced number of drive points, no over dimensioning for future phases.
- Separate plies for optimized ply split, low tensile MD/CD ratio and better formation.
- Long dewatering tables for optimized headbox flows and gentle dewatering.
- Optimized number of dewatering elements and with low friction covers.
- Minimized or no open draws from press section to the dryers.
- Sizing of auxiliary systems.

Achievable results:



- *Lowest maintenance cost per ton produced*
- *Lowest man hours per ton produced*
- *Minimal environmental impact*
- *Record setting EBITDA*
- *World class uptime efficiency*

Reference Projects

- MMTI participated in three projects that are used as reference in this article.
- A new liner board machine installed with brand new OCC recycling pulp line.
- Conversion of two existing (newsprint/LWC grade) machines into high efficient kraft/fluting machines with very low capital investment for OCC line and fewer machine up gradation.

Description	Units	New		
		Mill #1	Mill #2	Mill #3
Furnish				
OCC	%	90	90 - 100	90 - 100
Mixed Waste	%	10	0 - 10	0 - 10
Grade of Paper		Linerboard	Medium	Medium
Basis Wt.	lb / 1000 sq.ft	20 - 35	20 - 26	20 - 26
Year of Comission		Jul-2013	Dec-2013	Jan-2016
Reel production	stpd	1874	1200	596
Reel production	TPY	6,00,000	3,84,000	1,90,720

Compact Layout Design

Equipment Layout Design:

- Design efficient & compact **“L”-Shape** layout.
- **“L”-Shape** layout will reduce total pipeline and cable linear lengths and provide shortest access.
- **“Single department”** concept (Common DCS for OCC Stock Prep and Wet End system). An efficient way of operation.
- Layout will be designed with **“Plug & Play”** concepts.



Centralised rejects handling system

Design Concept

- Compact foot print & Robust design.
- Eliminates use of forklift and automated reject handling.
- Increases safety, Operating efficiency and low cost operation.
- System designed for continuous discharge.
- Operator and Maintenance friendly equipment.
- Efficient way of segregation of rejects (metals, plastics & fiber).

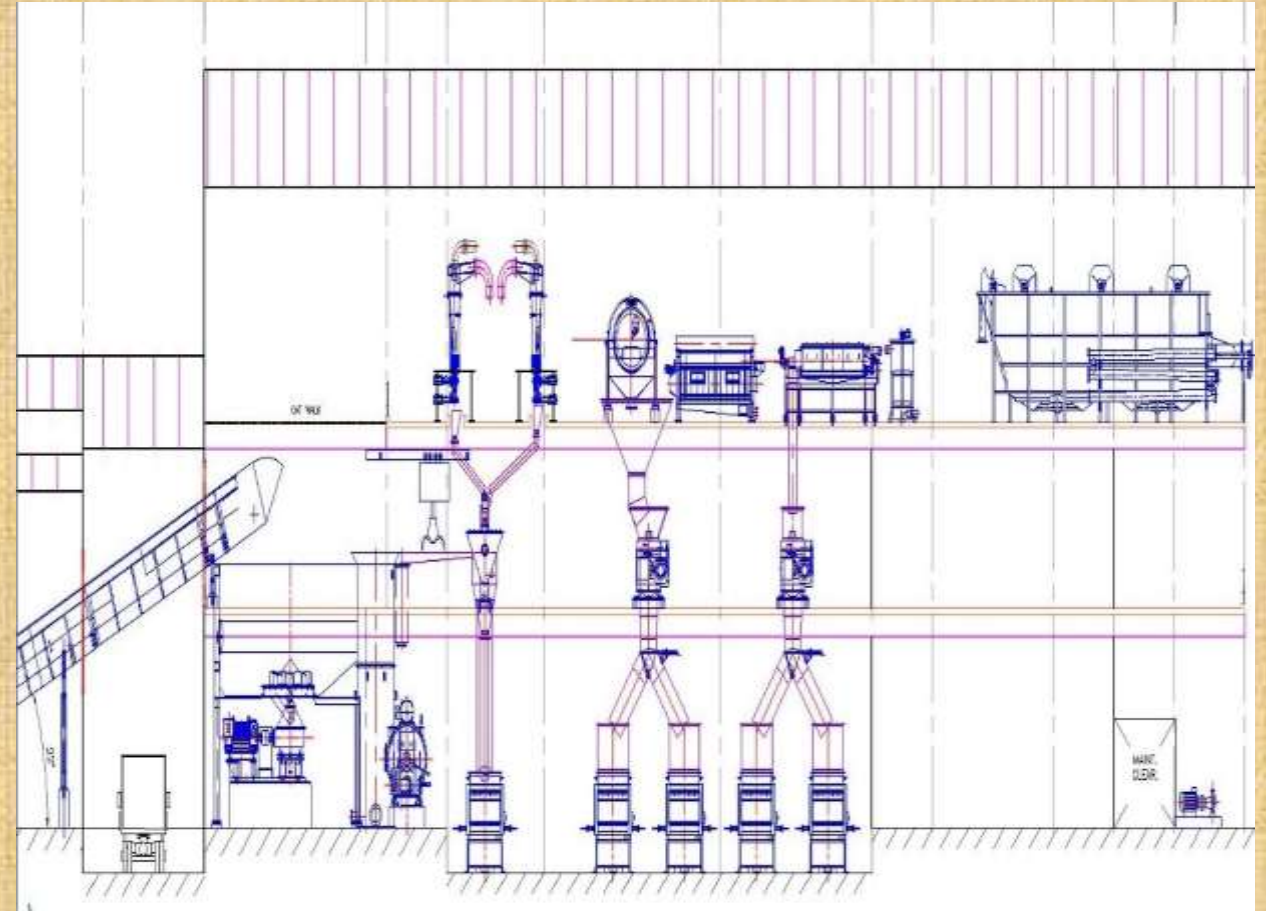

Headbox upgradation

- The headbox as a link from the approach flow system to the forming section is one of the most important tools for achieving best paper sheet properties. Fulfilment of best sheet quality criteria such as CD basis weight profile, fiber orientation, homogeneous sheet structure, and so on, largely depends on the headbox concept.
- Packaging grade fluting/linerboards, is greatly measured by the selection of headbox and flow patterns would strongly decide the end user's (Box converting/manufacturer) service demands such as compressive strengths (RCT, SCT, ECT,BF & BCT), tensile stiffness index (TSI), low tensile MD/CD ratio and so on.
- Though the RCT and burst test are the most commonly accepted methods in the Asian region, SCT is the efficient parameter to define both compressive and structural capabilities of linerboards.

Headbox with Dilution water profile control

Benefits:

- More uniform basis weight and fibre angle profiles.
- Slice can be built smaller and sturdier which has several advantages.
- Do not shrink excessively in the cross direction.
- Dilution can be varied significantly without influencing the total flow rate from the module.

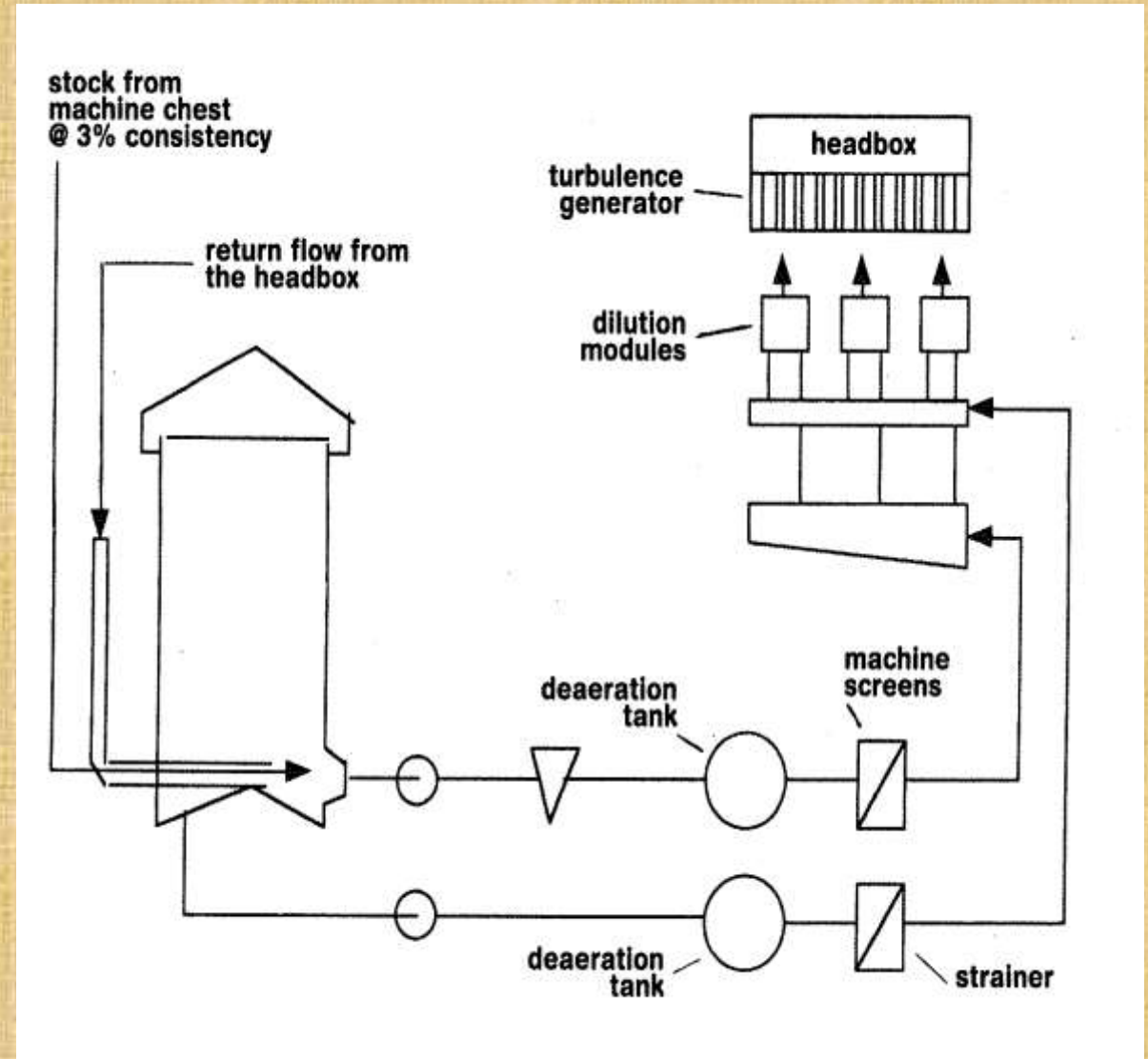

Press section upgradation & Steam blow box

Shoe Press

- High savings of energy & capital cost.
- Increase of sheet dryness after Shoe press from 45 to 50%.
- 20% less water to evaporate.
- Reduction in number of dryer cans.
- High sheet dryness & reduction in CD shrinkage.

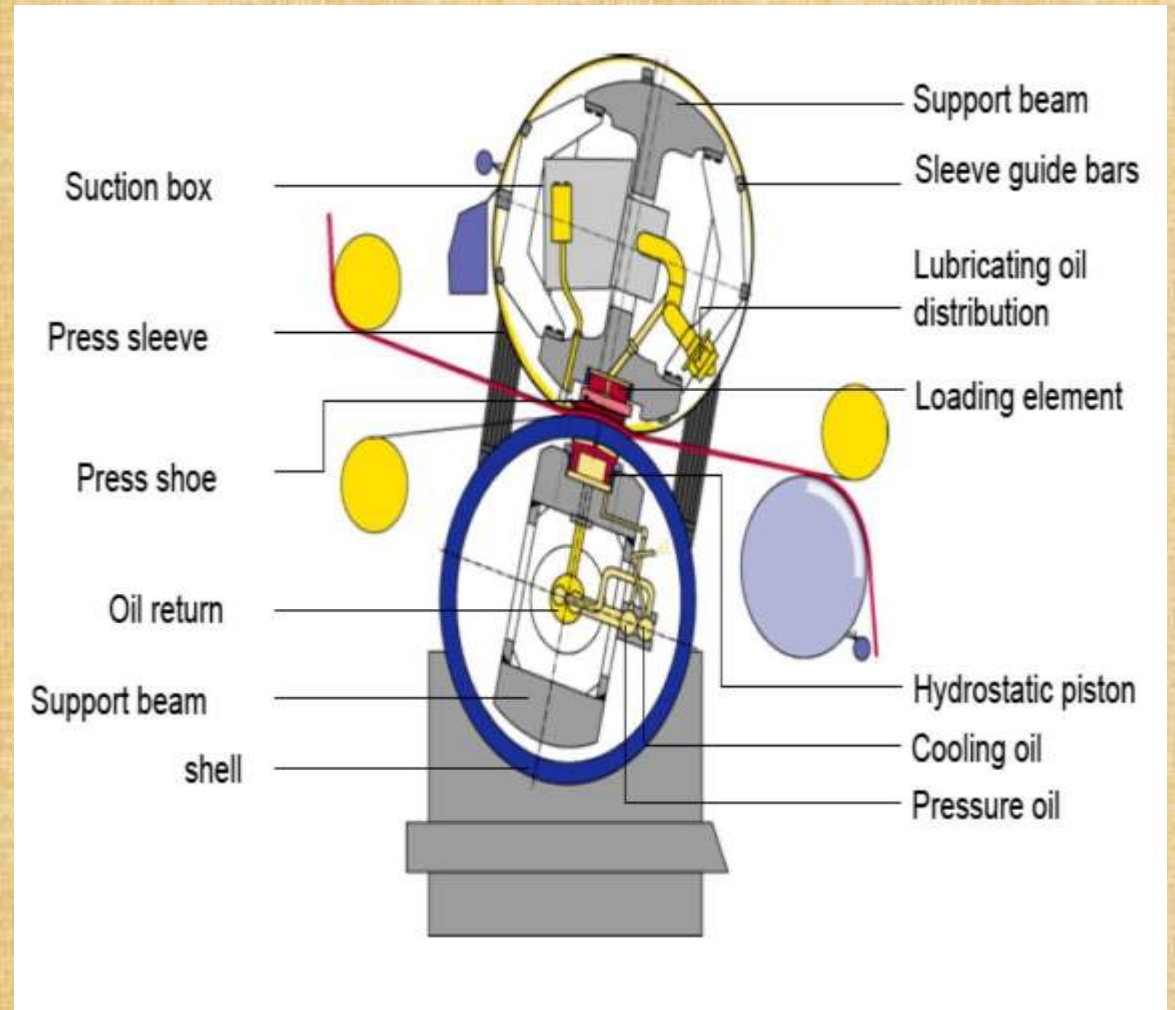

Press section upgradation & Steam blow box

Tri-Nip

- Tri-nip press section with shoe press in 3rd nip position is beneficial for fluting/liner grades of lower and intermediate basis weight ranges.
- Attains appreciable smoothness and higher dryness value.
- Eliminates open draw through press section.

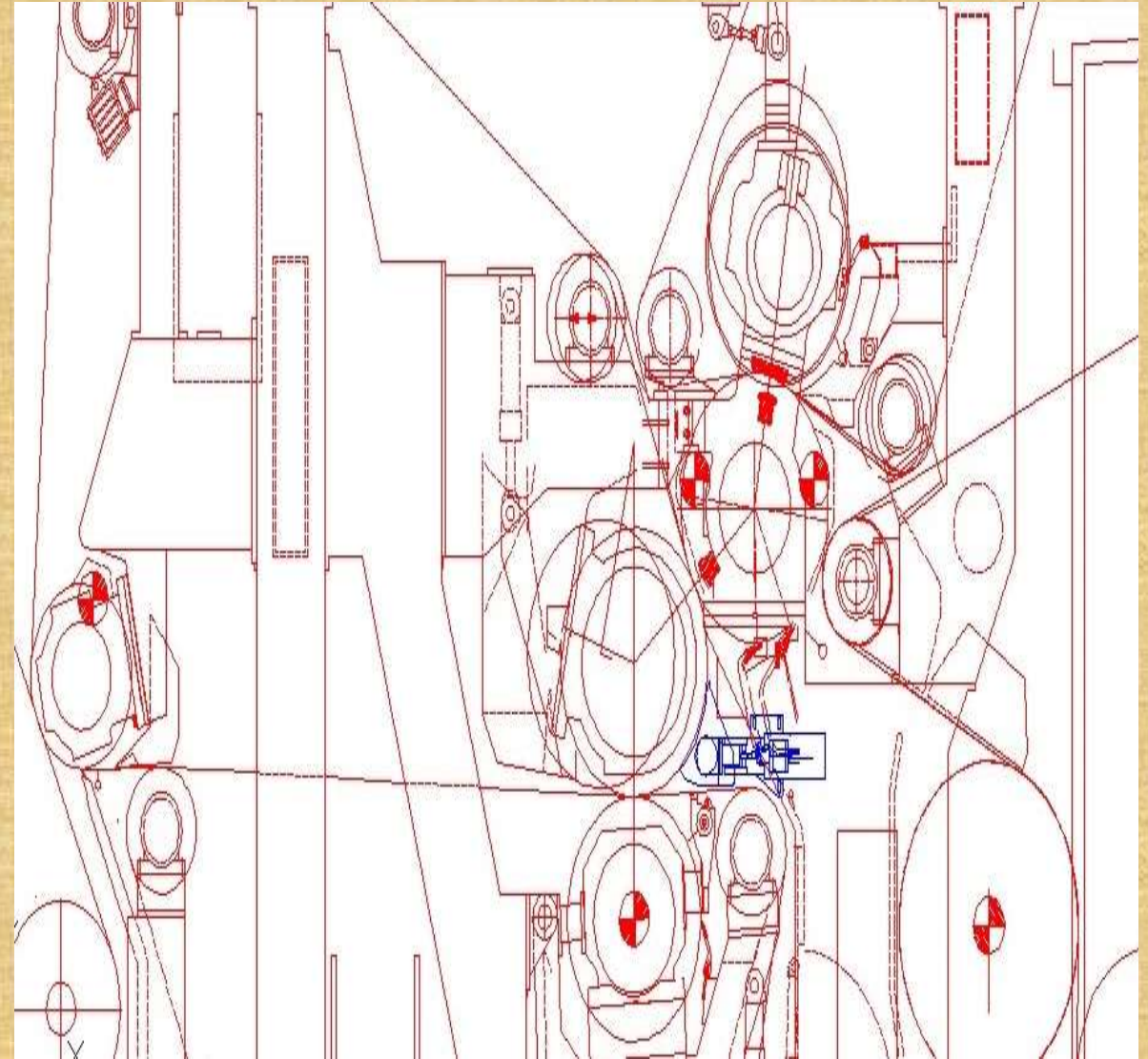

Press section upgradation & Steam blow box

Double felted Shoe / LNP Press

- One or two separate shoe presses with double felted arrangement is recommended for higher basis weight linerboard grades.
- A serious drawback of double felting is the doubled rewetting.

Steam blow box

- Increasing sheet temperature from 10 - 14 °C in the press section will improve sheet dryness by 1%.
- 3-4% decrease in steam consumption in dryer section .
- Avoids sheet picking problem.

Vacuum system upgradation with Ecopump turbo blower

- Replacing the conventional liquid ring vacuum pumps with high energy & efficiency multi-stage turbo blower.
- Vacuum blower usage will impact the capital cost considerably, but will also create substantial cost saving on energy over long operation.
- Further, by substituting with latest state of the art technology Eco pump turbo blower preserves layout space and easy maintenance.

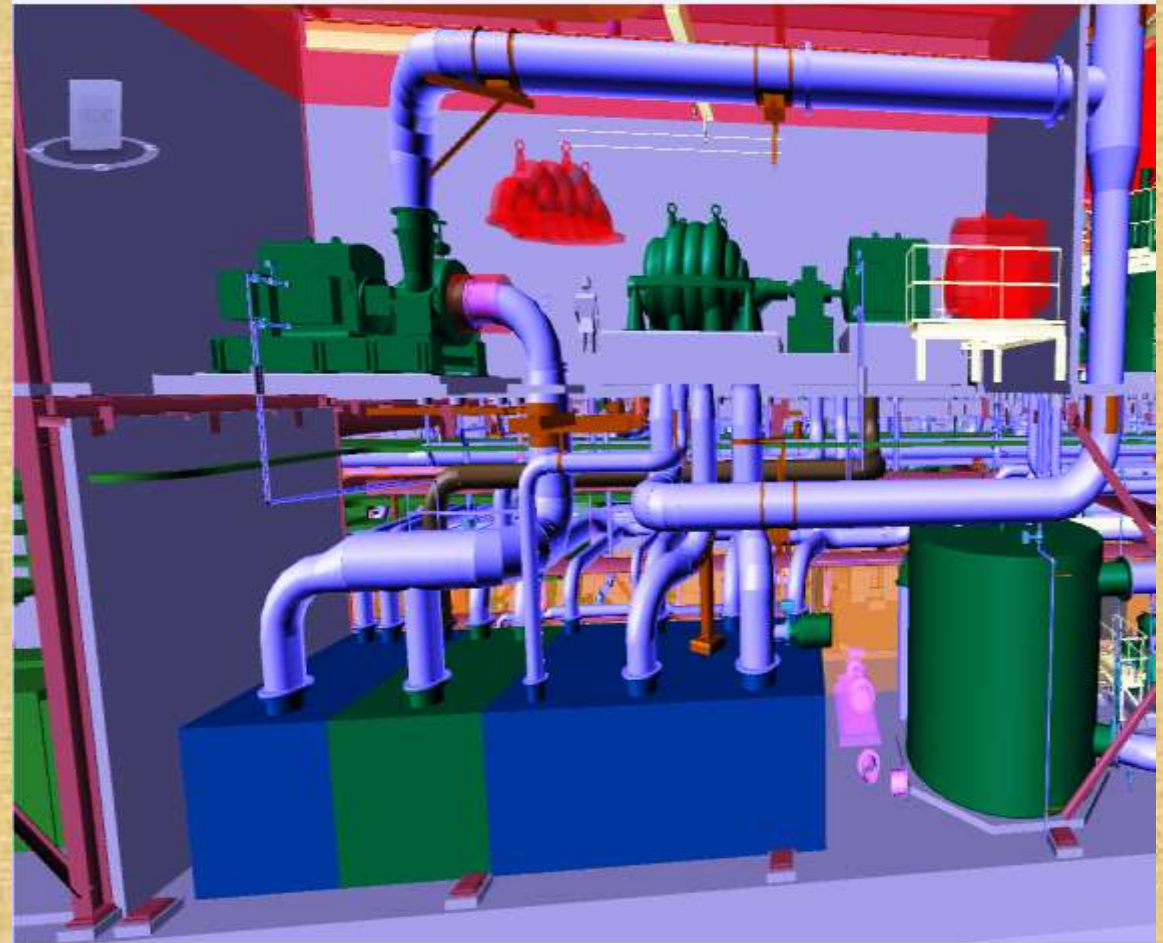

Potential Energy from outbound effluent & PM condensate

- Final Effluent to ETP & PM return condensate are sources of heat energy.
- The potential energy can be utilized to pre-heat the fresh water.
- Resultant warm water is used in PM shower water.

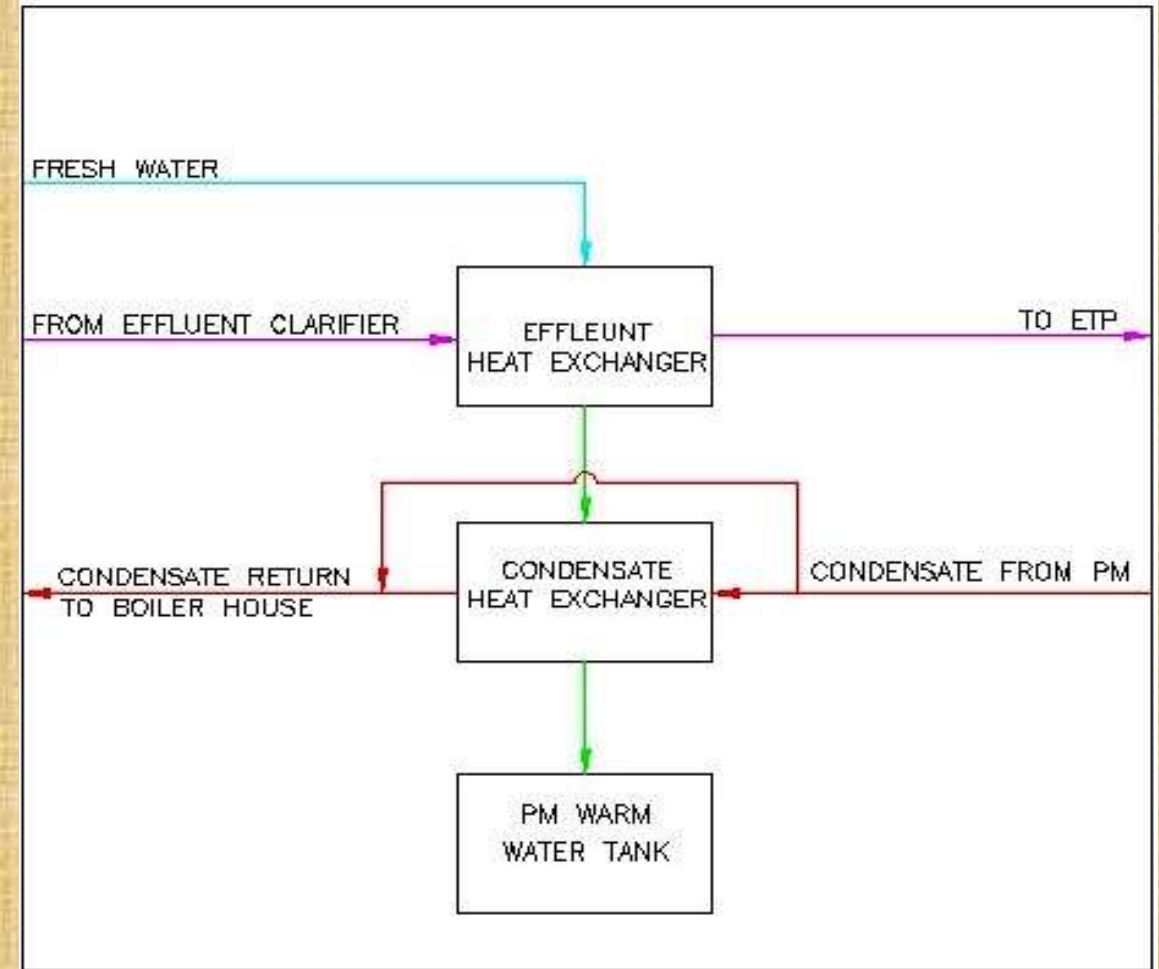

Conservation of fresh water

Elimination of Sealing Water in Process Pumps & Agitators

- All stock and water pumps, agitators for tanks and towers are equipped with dynamic seals.
- Results in lower operating cost (Consumption of low fresh water, energy and effluent).
- Our reference mills are good example on fresh water conservation and developed a bench mark for other paper mills in the USA.



Closed loop shower water system

- Recover the shower water spilled in wire pit by introducing a gravity filter and reuse it.
- Filtrate from Uhle box seal tank also can be reused for PM Showers with the help of simple filters which is quite common in practice.

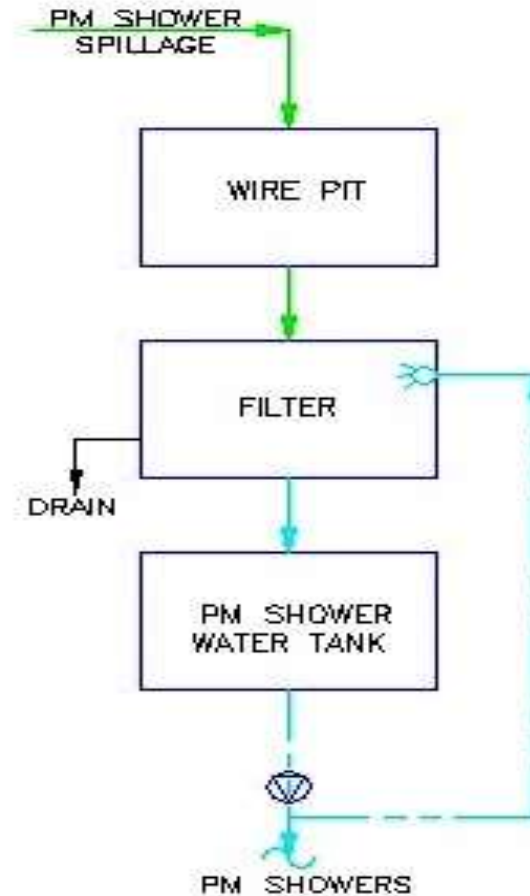

Fully Automated OCC Feed System

OCC Walking Floor Conveyor

- Better pulper performance and uniform discharge consistency.
- Increased plant uptime.
- Higher production probabilities and less operational cost.
- Process stability and uniform pulp quality since the classification of bales based on fibre quality is possible on the walking floor conveyor.



Benefits of OCC Sequential Feed System

LINE 1

OCC FEEDING SEQUENCE

NOTES:

1. Sequence repeats itself every 5th bale
2. Single feed
3. Feed mixed waste/postal/hardpack as directed
4. Effective 12 hours before HPL grade change
5. Bale OCC feeding sequence may be adjusted to account for deviations in average bale weight

BALE KEY

Symbol	Bale Description	Avg Bale Weight
A	A Bale/Non-Grocery	900#
B	B Bale	1500#
C	C Bale	1500#
G	Grocery Bale	720#
GW	Wegmans Bale	1000#
F	FOE Bale	1275#
P	Postal Bale	1160#
HP	Hard Pack	1160#
M	Mixed Waste Bale	1210#



To Pulper



Excellence in housekeeping

Grapple Hoist

- Eliminates the floor wetting and rejects spill below the Pulper & junk trap.
- No dumping of rejects and water at the bottom through junk trap discharge.
- Eliminates the troublesome operation of junk trap jam removal and dumping valves.



Excellence in housekeeping

Spill containment system

- Spills from pulper, dump tower and operating floor stock tankages are piped to a dedicated spill containment tank located near pulper.
- Avoid the pulper and other pulp tankages overflow to the pulper pit through drains/trenches which is tedious when the pulp slurry consistency is higher.
- The idea is to have no pulp flow in the drain/trench.

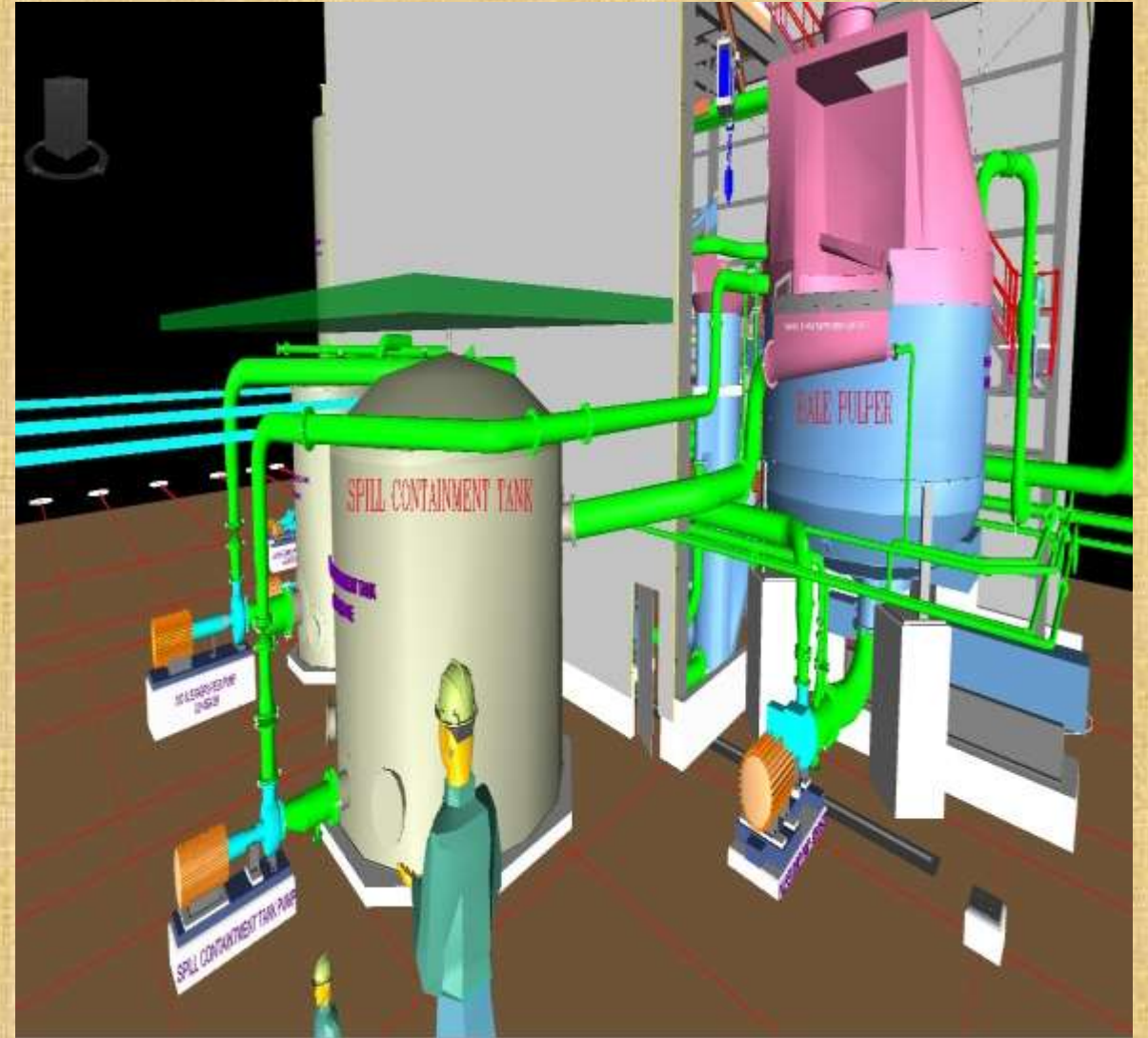

Minimill White Water circuit

- Prompt usage of OCC filtrates and PM excess white water circulation is the highlight of “Minimill” concept.
- Eliminates separate fibre recovery system.
- Entire PM excess white water consumed in OCC system dilution and rest are stored in a water storage tower.
- During enormous PM white water flow, it is treated in the process clarifier and taken back to the process.
- Fresh water is limited to specific locations in the paper machine area.

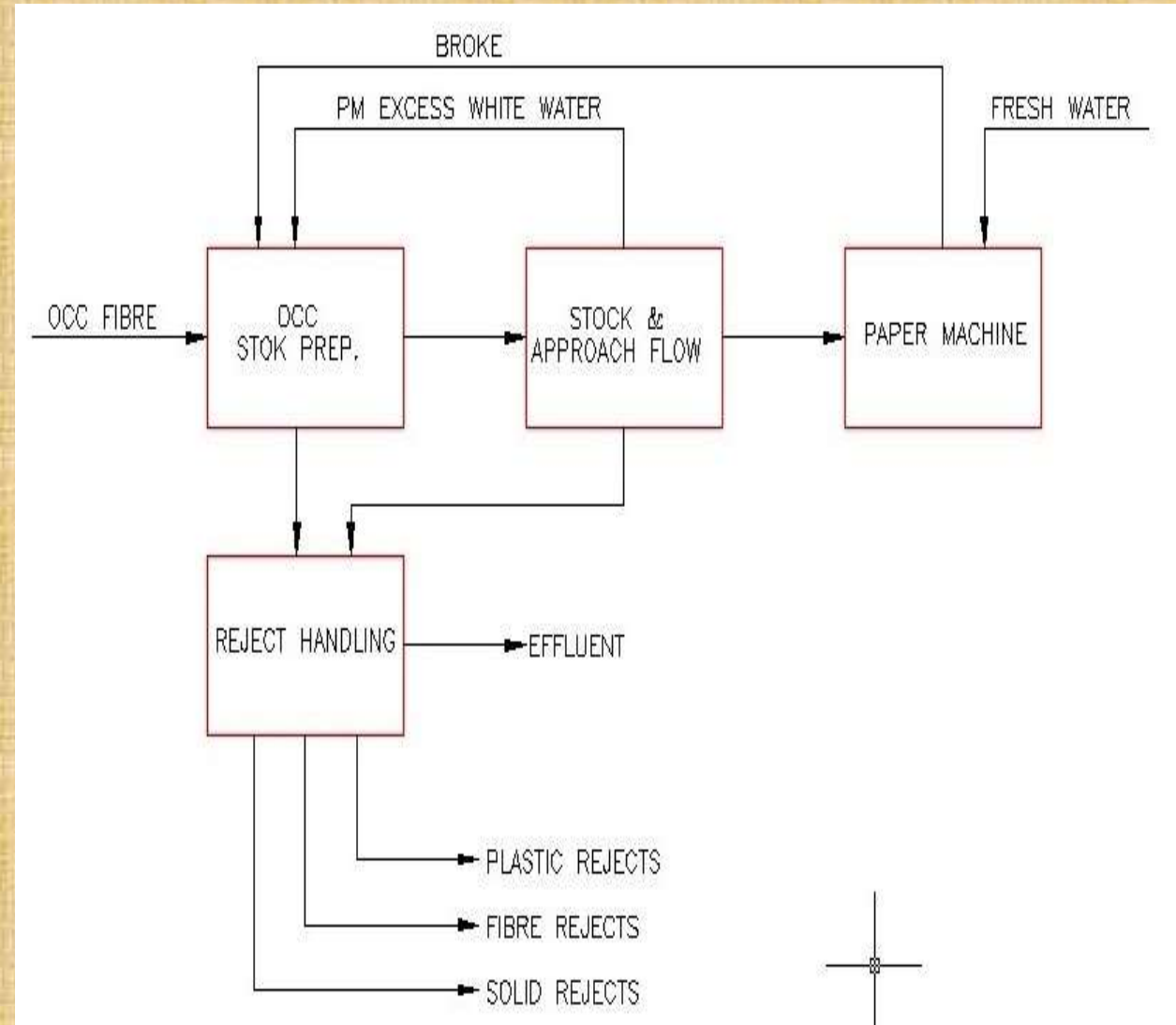

Conclusion

- Though this article will not cover the entire liner board machine areas starting from the development of preliminary concepts for each specific machine configuration to the saleable end product in the loading bay, it may enlighten every paper maker significantly to conceive more new ideas and serve the fluting and liner board industries to their best.
- The performance targets tabulated here against the traditional way, is achievable if all the aforesaid concepts, designs and changes are adopted.

mmt's Recipe for Success!

D Development **E** Engineering **P** Procurement **C** Construction **O** Operations **M** Maintenance

MMT is a full service DEPCOM firm servicing the paper industry, MMT has been involved in designing, building and operating some of the most efficient and profitable mills in the USA.

MMT's Recipe



Reel Results

Performance Index	MMT Targets	Traditional Targets
Safety RIR	<1.0	>1.0
Tons per Year/Person	4000	2000
Uptime %	94%	90%
Steam/Ton	<2500	>3200
Water/Ton	<800	>1500
kWh/Ton	<500	>650
Fiber Yield %	91-93%	85-92%
Maintenance Cost/Ton	1x	4x

MiniMill Technologies Inc
— Ingenuity Innovation Integrity —